

Data Sheet



Article number: 2011461240

Description: E+G Stainless steel lock pin
GN 114.6-12-40

Measures

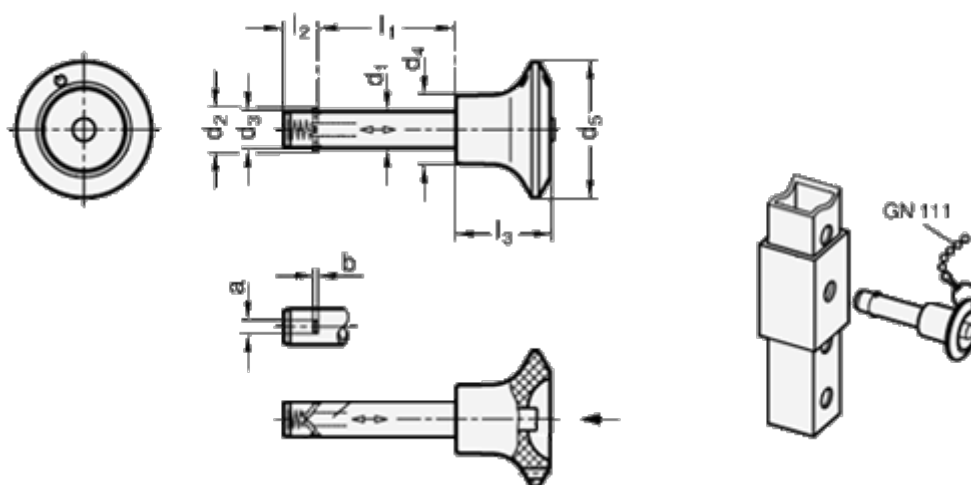

a = 61.0	l3 = 26
d1 = 12	Resilience (N) = 4
d2 = 14.8	
d3 = 11.9	
d4 = 18.0	
d5 = 34	
l1 = 40	
l2 = 11.3	